

1

2

3

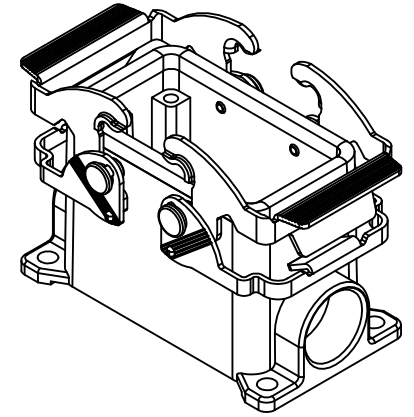
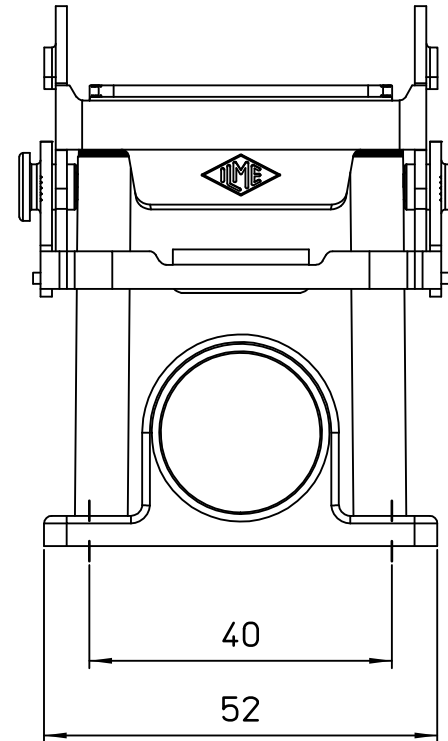
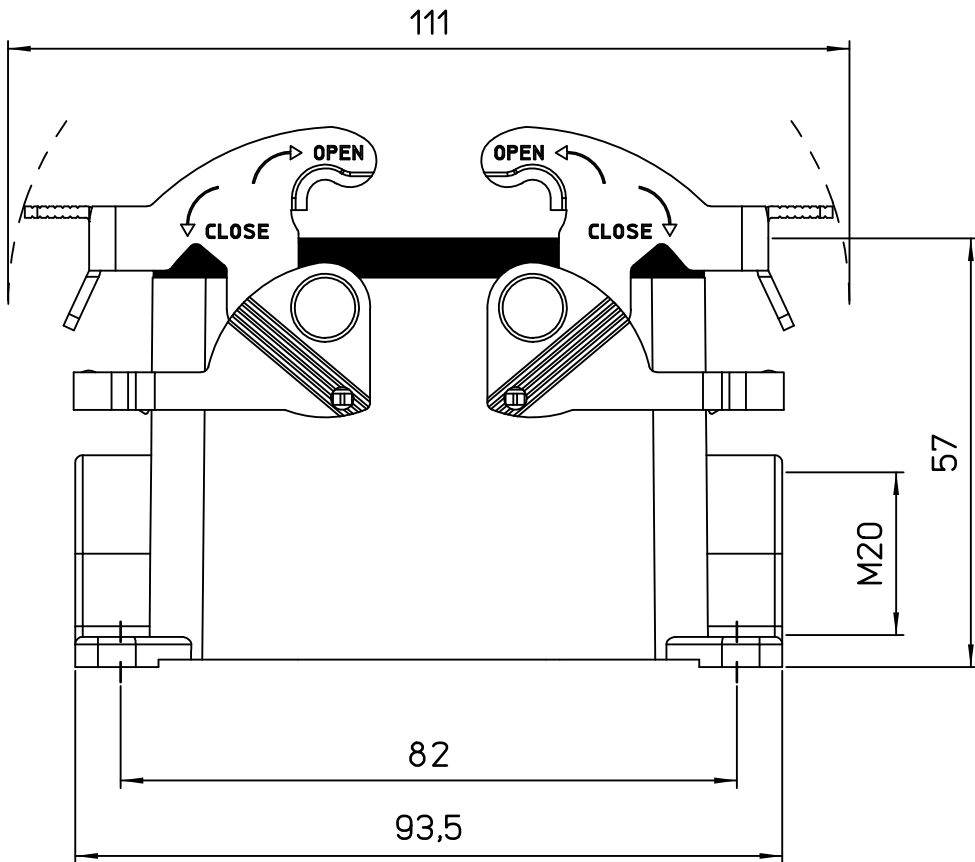

Dimensions in mm

Simplified representation with dimensions without tolerance

Original Size A4

MVPR 10.20

Date 20/09/22

Surface mounting housing, size "57.27", 1x M20 side entry,

Sign. G. Renna

with 2 levers, 180 °C

Scale
1:1



1

2

3